

18060-1/18260-1

PLUS

CE DS/EN 71-8

Advarsel. Kun til privat brug.
Warning. Nur für privaten Gebrauch.
Varning: Endast för privat bruk.
Warning. For private use only.
Avertissement. Réservé à un usage privé.



Fra 1 år
Von 1 Jahren
Från 1 år
From 1 years
A partir de 1 ans

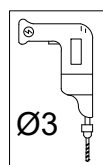
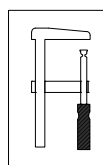
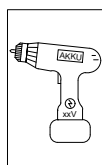
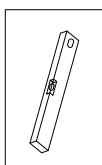
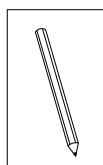
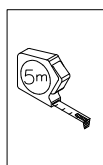

PLUS A/S, Ådalen 13B, DK - 6600 Vejen
WWW.plus.dk, plus@plus.dk

Senest revideret:
Letzte Änderung:
Senast reviderat:
Last updated:
Dernière révision:
1 - 2025

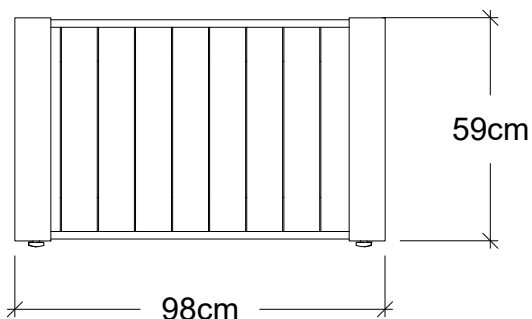
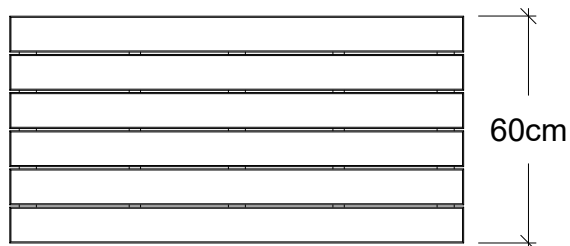
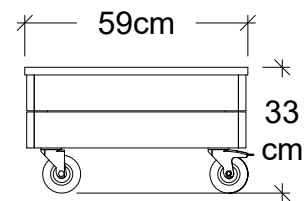
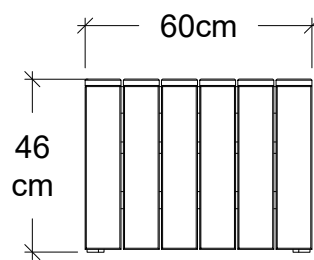
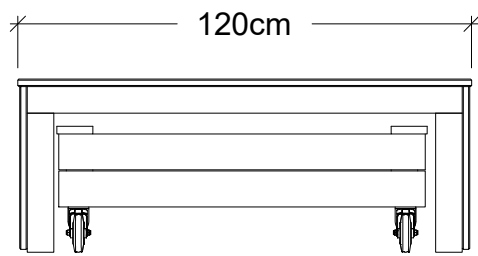

Sandkassen fyldes med rent sand, undgå sand med tilsætningsstoffer.

Füllen Sie den Sandkasten mit sauberem Sand, vermeiden Sie Sand mit Zusätzen.

Fyll sandlådan med ren sand, undvik sand med tillsatser.

Fill the sandbox with clean sand, avoid sand with additives.

Remplissez le bac à sable avec du sable propre, évitez le sable contenant des additifs.

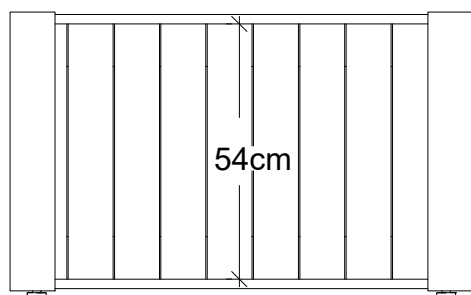
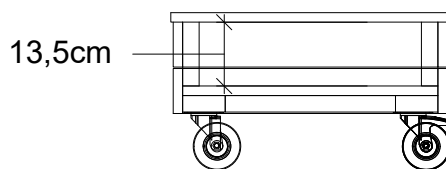
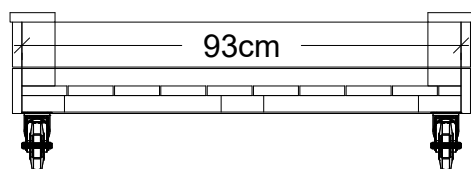

$$13 \times 54 \times 93 \text{cm} = 0,065 \text{ m}^3 = 65 \text{L}$$

$$1 \text{L sand} = 1,6 \text{kg}$$

Forslag til mængde:
Empfohlene Menge:
Föreslagen mängd:
Suggested quantity:
Quantité suggérée :

$$37 \text{L} = 60 \text{kg}$$

Placering:

Fun sandkasse med hjul, skal nemt kunne rulles inden under bænken og gemmes af vejen, når den ikke er i brug.

Sandkasse og bænk placeres på et plant underlag.

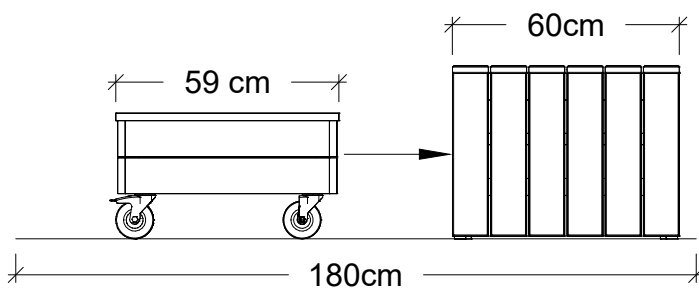

Trædelene er ubehandlede og **skal** males inden montage.

Alle overflader (indvendigt og udvendigt) påføres en transparent eller heldækkende træbeskyttelse.

Der må ikke ændres på konstruktionen.

Advarsel. Må kun anvendes under opsyn af en voksen.

Hjul skal være låst, når sandkassen er i brug eller opbevares under bænken.



Vedligeholdelse:

Det er vigtigt at holde øje med at bænk og sandkasse er i orden.

Kontroller jævnligt og mindst hver 3 md. bænk og sandkasse:

- *At konstruktionen er intakt, evt udskiftning af slidte eller defekte dele.*
- *Hjul skal smøres med syrefri olie.*
- *At der er rent sand i sandkassen, undgå sand med tilsætningsstoffer.*

UBEHANDLEDE PRODUKTER:

På Plus.dk kan du finde yderligere information om hvordan du skal efterbehandle og vedligeholde produktet.

Sådan gør du:

Klik på  i topmenuen for at finde hjælp. Søg på **produkt navn** eller **varenummer** i søgefeltet på plus.dk og find alle de gode links med nyttig viden under det enkelte produkt.

Gem denne vejledning til senere brug.

Platzierung:

Der FUN-Sandkasten mit Rädern sollte sich leicht unter die Bank gerollt und aus dem Weg geräumt werden, wenn sie nicht benutzt wird.

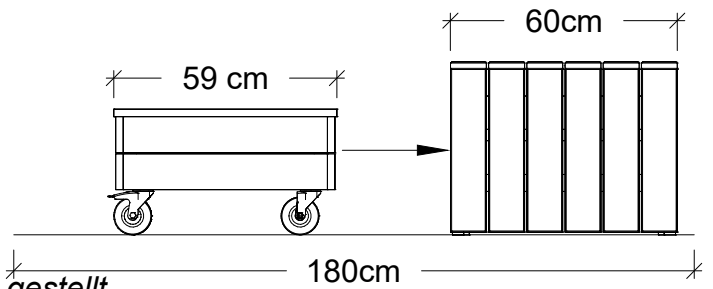

Der Sandkasten mit Bank wird auf eine ebene Fläche gestellt.

Die Holzteile sind unbehandelt und müssen vor dem Zusammenbau lackiert werden.

Alle Oberflächen (innen und außen) sind mit einem transparenten oder vollflächigen Holzschutz beschichtet.

Nehmen Sie keine Änderungen an der Konstruktion vor.

Achtung! Nur unter Aufsicht von Erwachsenen benutzen.

Die Räder müssen verriegelt sein, wenn der Sandkasten in Gebrauch ist oder unter der Bank gelagert wird.



Wartung:

Es ist wichtig, die Bank und den Sandkasten in gutem Zustand zu halten.

Kontrollieren Sie die Bank und den Sandkasten regelmäßig, mindestens aber alle 3 Monate:

- *Prüfen Sie, ob die Konstruktion intakt ist, und ersetzen Sie gegebenenfalls verschlissene oder defekte Teile.*
- *Die Räder müssen mit säurefreiem Öl geschmiert werden.*
- *Sauberer Sand im Sandkasten, kein Sand mit Zusätzen.*

UNBEHANDELTE PRODUKTE:

Auf Plus.dk finden Sie weitere Informationen über die Behandlung und Pflege des Produkts.

Wie man das macht:

Klicken Sie  im oberen Menü, um Hilfe zu finden. Suchen Sie nach dem Produktnamen oder der Artikelnummer in der Suchleiste auf

plus.dk und finden Sie alle guten Links mit nützlichen Informationen unter dem jeweiligen Produkt.

Speichern Sie diesen Leitfaden für den späteren Gebrauch.

Placering:

FUN sandlåda med hjul ska vara lätt att rullas in under bänken och förvaras undan när den inte används.

Sandlådan med bänk placeras på en plan yta.

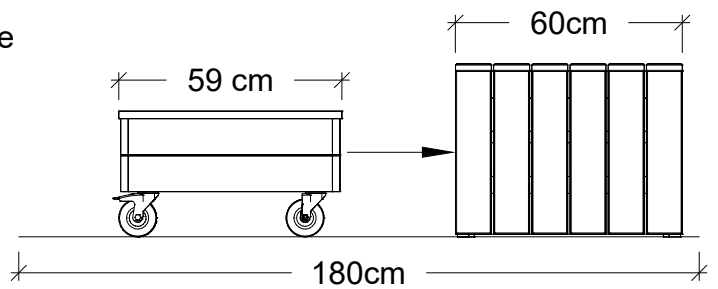

Trädelarna är obehandlade och måste målas före montering.

Alla ytor (in- och utvändigt) är belagda med ett transparent eller heltäckande träskydd.

Gör inga ändringar i konstruktionen.

Varning. Använd endast under uppsikt av vuxna.

Hjulen måste vara låsta när sandlådan används eller förvaras under bänken.



Underhåll:

Det är viktigt att hålla bänken och sandlådan i gott skick.

Kontrollera bänken och sandlådan regelbundet och minst var 3:e månad:

- *Att konstruktionen är intakt, byt vid behov ut slitna eller defekta delar.*
- *Hjulen måste smörjas med syrafri olja.*
- *Ren sand i sandlådan, undvik sand med tillsatser.*

OBEHANDLADE PRODUKTER:

På Plus.dk hittar du mer information om hur du behandlar och underhåller produkten.

Hur du gör det:

Klicka i  toppmenyn för att hitta hjälp. Sök efter produktnamn eller artikelnummer i sökfältet på plus.dk och hitta alla bra länkar med användbar information under den enskilda produkten.

Spara den här guiden för senare användning.

Location:

Fun sandbox with wheels should be easy to rolled under the bench and stored out of the way when when not in use.

The sandpit with bench is placed on a flat surface.

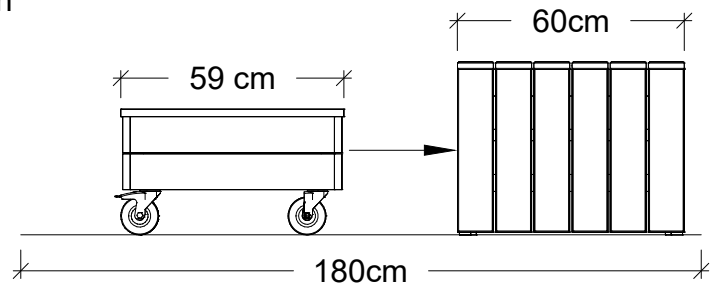

The wooden parts are untreated and must be painted before assembly.

All surfaces (interior and exterior) are coated with a transparent or full-coverage wood protection.

Do not make any changes to the construction.

Warning. Use only under adult supervision.

Wheels must be locked when the sandbox is in use or stored under the bench.



Maintenance:

It is important to keep the bench and sandbox in good condition.

Check the bench and sandpit regularly and at least every 3 months:

- *That the construction is intact, if necessary replace worn or defective parts.*
- *Wheels must be lubricated with acid-free oil.*
- *Clean sand in the sandbox, avoid sand with additives.*

UNTREATED PRODUCTS:

On Plus.dk you can find further information on how to treat and maintain the product.

How to do it:

Click in the top  menu to find help. Search by product name or item number in the search bar on plus.dk and find all the great links with useful information under the individual product.

Save this guide for later use.

Lieu d'implantation :

Le bac à sable FUN à roulettes doit pouvoir être facilement

Le bac à sable à roulettes doit pouvoir être roulé sous le banc et rangé à l'écart lorsqu'il n'est pas utilisé.

lorsqu'il n'est pas utilisé.

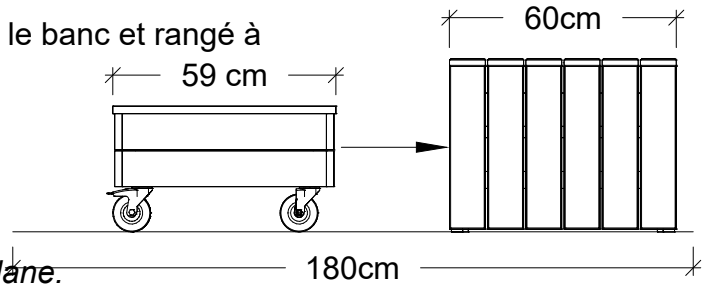

Le bac à sable avec banc est placé sur une surface plane.

Les pièces en bois ne sont pas traitées et doivent être peintes avant l'assemblage.

Toutes les surfaces (intérieures et extérieures) sont recouvertes d'une protection transparente ou complète pour le bois.

Ne pas apporter de modifications à la construction.

Avertissement. N'utiliser que sous la surveillance d'un adulte.

Les roues doivent être bloquées lorsque le bac à sable est utilisé ou rangé sous le banc.



Entretien :

Il est important de maintenir le banc et le bac à sable en bon état.

Vérifiez le banc et le bac à sable régulièrement et au moins tous les 3 mois :

- *Que la construction est intacte, si nécessaire remplacer les pièces usées ou défectueuses.*
- *Les roues doivent être lubrifiées avec de l'huile sans acide.*
- *Sable propre dans le bac à sable, éviter le sable avec des additifs.*

PRODUITS NON TRAITÉS :

Sur Plus.dk, vous trouverez de plus amples informations sur la manière de traiter et d'entretenir le produit.

Comment procéder :

Cliquez sur  le menu supérieur pour trouver de l'aide. Faites une recherche par nom de produit ou par numéro d'article dans le champ de recherche de

plus.dk et trouvez tous les liens utiles sous le produit concerné.

Sauvegardez ce guide pour une utilisation ultérieure.

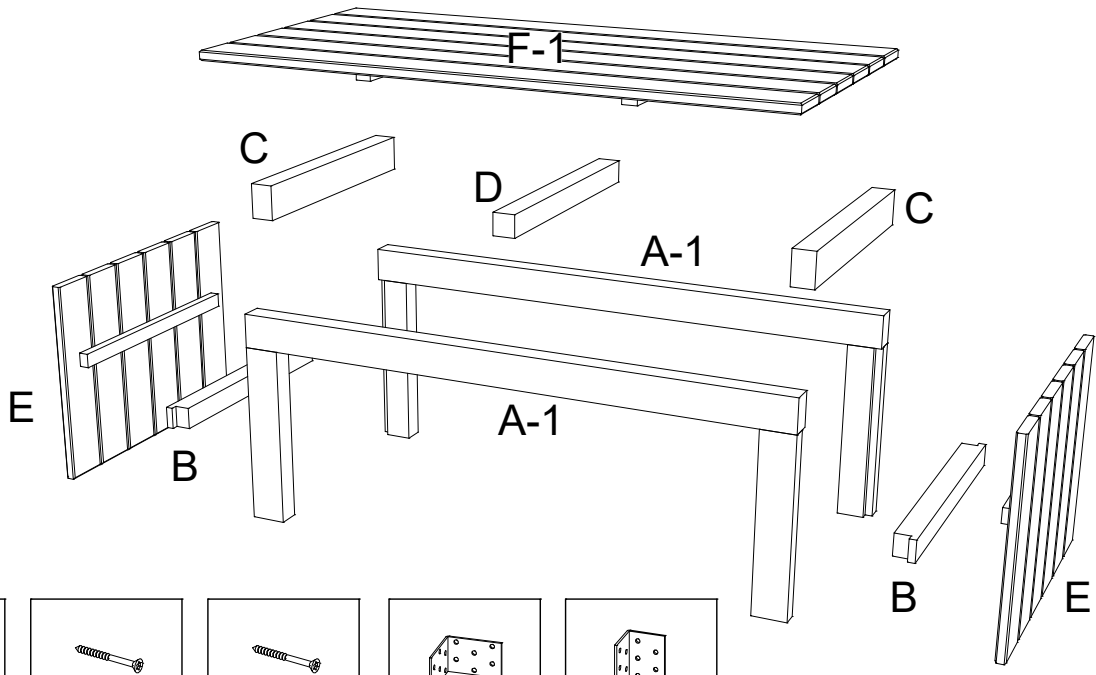



x 60
3,5 x 50mm



x 36
3,5 x 40mm

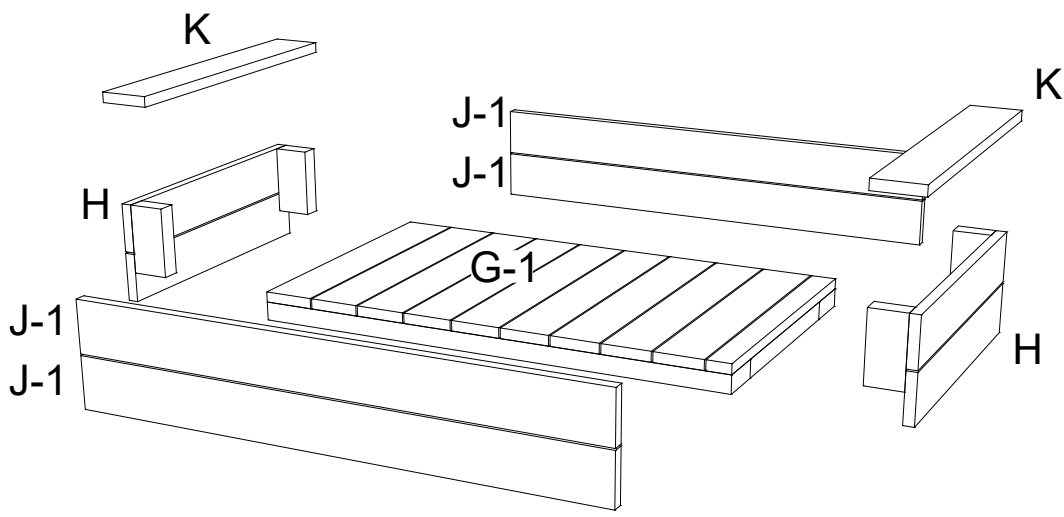

x 16
4 x 80mm



x 2
60x60x40



x 4
40x40x60





x 4
5 x 100mm



x 8
4 x 80mm



x 30
3,5 x 50mm

x 2



x 2
1953001

x 16
5 x 50mm

 18011-1
x 1

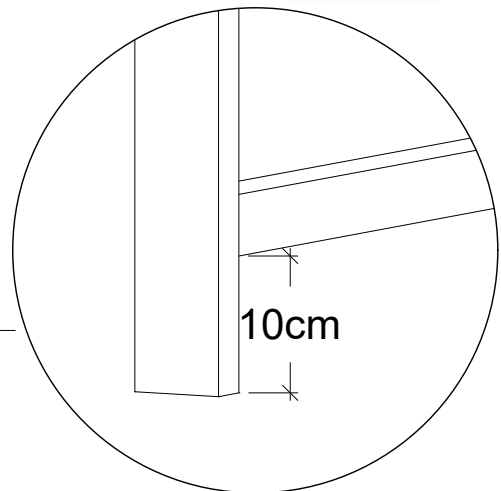
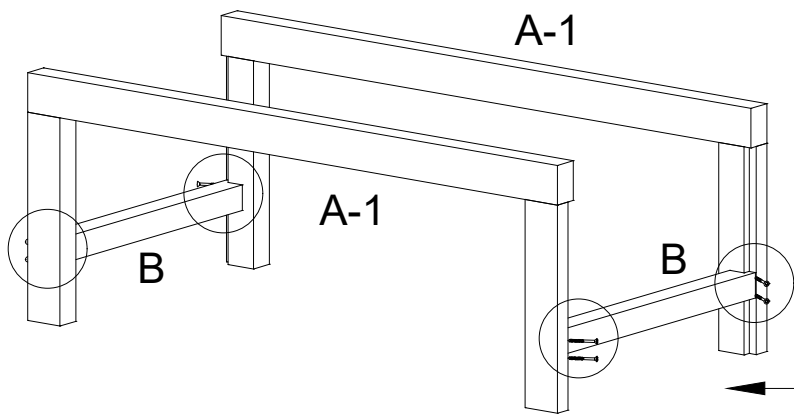

x 8
3,5 x 50mm



x 4
40x40x60

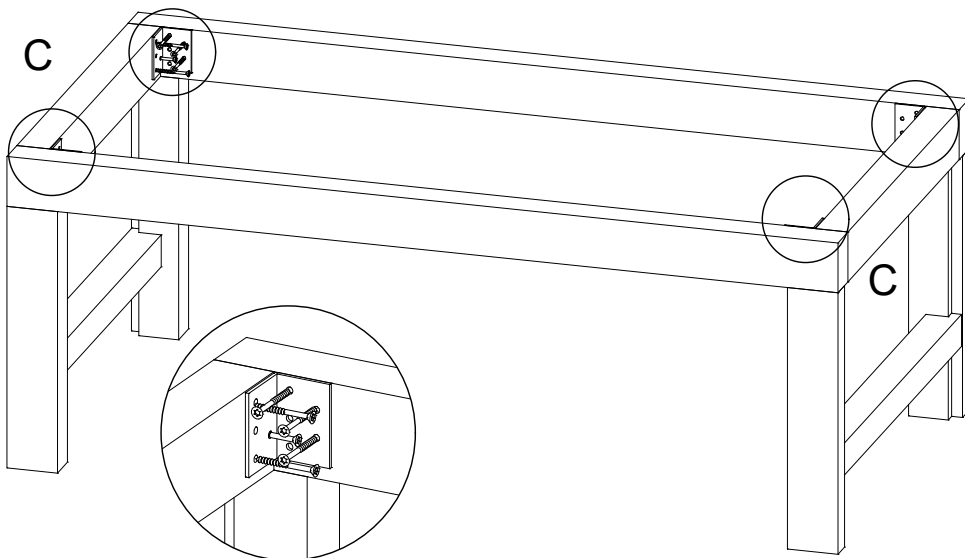

x 24
3,5 x 40mm



x 2
60x60x40

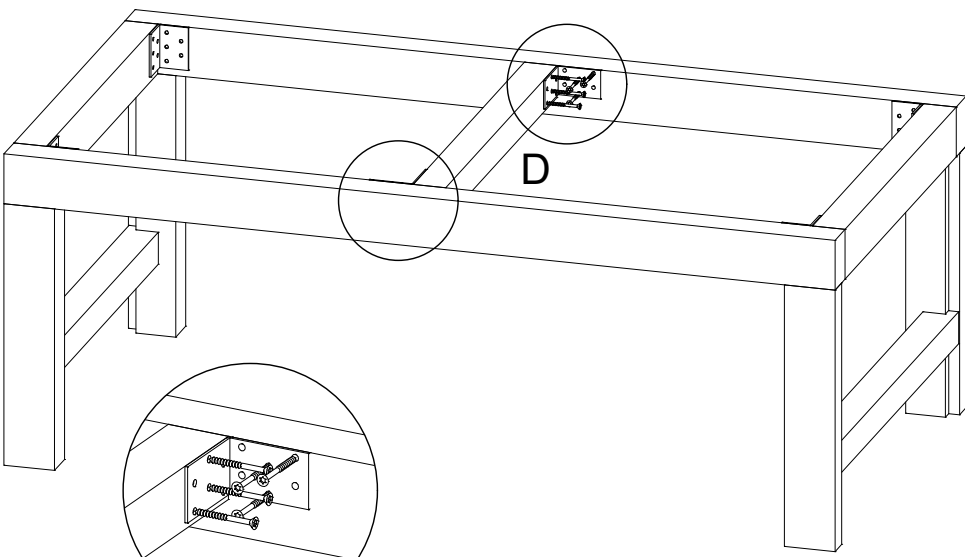

x 12
3,5 x 40mm

